

WONDER









Inspirée des lampes de poche de notre enfance, *Wonder* se décline en appliques et en lampes dans un format XL. Un brin de nostalgie dans cette collection aux nombreuses variantes grâce à une gamme de couleurs originales, mariées à nos finitions métalliques













Inspired by our childhood's flashlights, *Wonder* offers a variety of wall lights and XL lamps. An ounce of nostalgia in this wide-ranging collection with several original colors available, combined with metal finishing.



Finitions Finishes ①

 Laiton satiné SB Satin brass	 Graphite satiné SG Satin graphite	 Nickel satiné SN Satin nickel	 Cuivre satiné SC Satin copper
 Laiton poli PB Polished brass	 Graphite poli PG Polished graphite	 Nickel poli PN Polished nickel	 Cuivre poli PC Polished copper

Finitions Finishes ②

 Bleu foncé DB Dark Blue	 Bleu clair LB Light Blue	 Goyave GU Guava	 Bordeau DR Dark Red
 Mangue MA Mango	 Vert vintage VG Vintage Green		
 Laiton satiné SB Satin brass	 Graphite satiné SG Satin graphite	 Nickel satiné SN Satin nickel	 Cuivre satiné SC Satin copper

Matériaux Material

Tous – All Laiton massif et acier peint Solid Brass and painted steel	Diffuseur PMMA blanc texturé Textured white PMMA diffuser	Lampe de Table – Table Lamp Câble textile noir Black textile cable
--	--	---

Source Lamping

Lampe de table – Table lamp LED 1100 lm 2700°K	Alim. intégrée 110-220V Power supply 110-220V	Variable Dimmable
Appliques – Wall lights LED 430 lm 2700°K	230V direct 120V direct	Variable (phase cut) Dimmable (phase cut)

Designer

Émilie Cathelineau

Applique XS V1 – Wall light XS V1

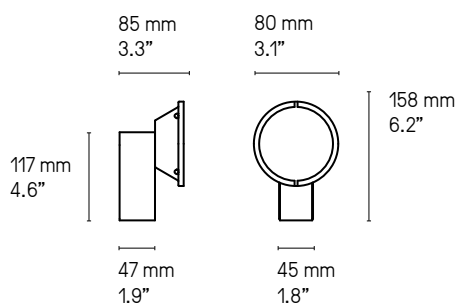

Applique XS V2 – Wall light XS V2

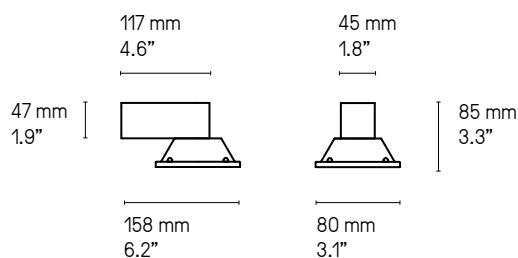

Les appliques Wonder ne sont pas réglables. V1 et V2 sont des modèles différents.
Wonder wall lights are not mobile. V1 and V2 are different fixed models.

Applique XL V1 – Wall light XL V1

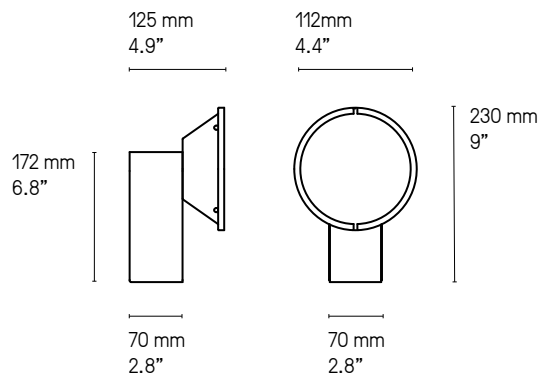

Applique XL V2 – Wall light XL V2

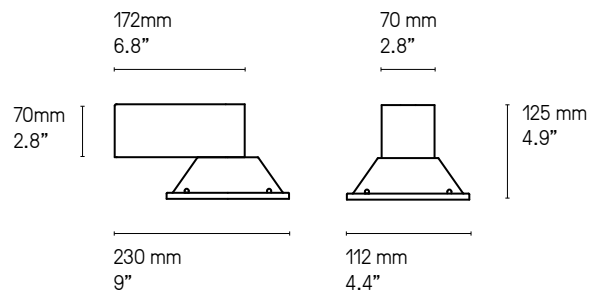

Lampe de table – Table lamp

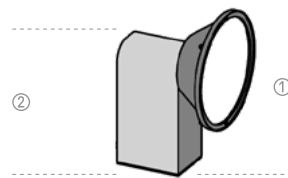
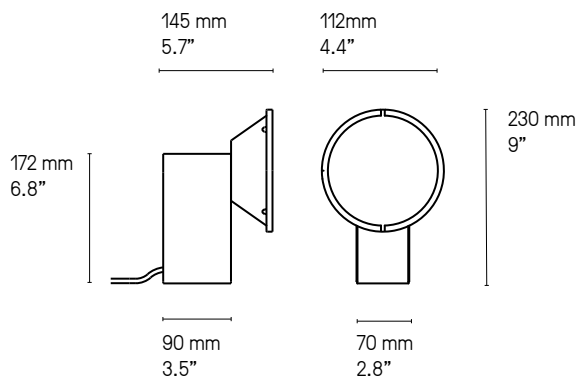

Lampes de table – Table lamps

- | | |
|----------------|----------------|
| A Wonder PB/SG | E Wonder SG/SB |
| B Wonder PG/MA | F Wonder SN/LB |
| C Wonder PN/DR | G Wonder SB/DB |
| D Wonder SB/GU | H Wonder SG/VG |

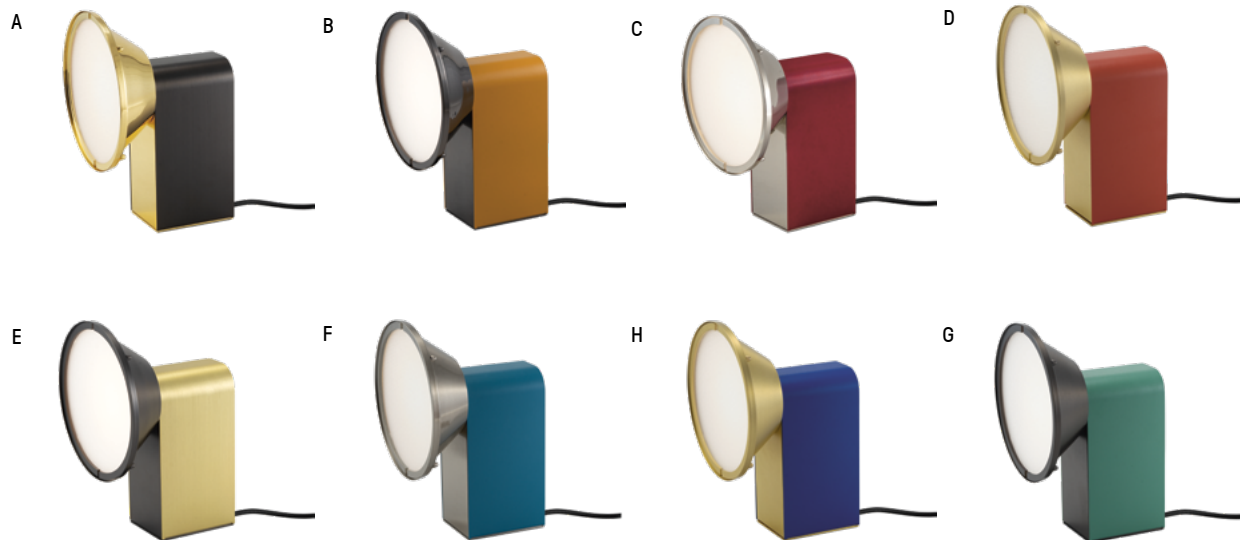

NUANCIER - FINISH OPTIONS



LAITON - BRASS

- | | |
|-------------------------------------|---|
| ① Laiton satiné
SB Satin brass | ② Graphite satiné
SG Satin graphite |
| ③ Nickel satiné
SN Satin nickel | ④ Cuivre satiné
SC Satin copper |
| ⑤ Laiton poli
PB Polished brass | ⑥ Graphite poli
PG Polished graphite |
| ⑦ Nickel poli
PN Polished nickel | ⑧ Cuivre poli
PC Polished copper |

ABAT-JOURS - LAMPSHADES



Drop Paper® 100



Drop Paper® 101

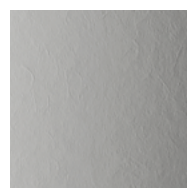

Drop Paper® 103

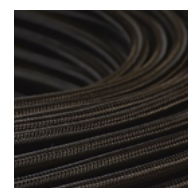

Tissu noir
Black textile



Chinette blanche
White chinette

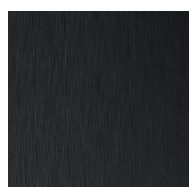

Chinette noire
Black chinette

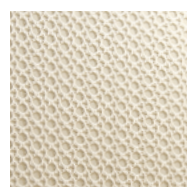

Duke
Duke



Tissu or
Gold textile

VERRERIE - GLASS



Opale
Opal

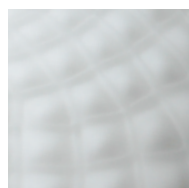

Opale et écaille
Opal and patterned



Claire et écaille
Clear and patterned

CONSEILS TECHNIQUES

Les caractéristiques techniques mentionnées dans ce document sont données à titre indicatif et sont susceptibles de subir des modifications. Ceci est lié à l'évolution rapide de la technologie LED.

Les dimensions sont approximatives et peuvent varier légèrement.

AMPOULES

Il est impératif de respecter les types et les puissances maximales préconisées sous peine de détériorer le luminaire. En cas de non-respect, la garantie ne pourra s'appliquer.

CONSEIL D'ENTRETIEN

Essuyage avec un chiffon doux, sans produits d'entretien. Nos produits étant vernis afin d'assurer la longévité du luminaire, il ne faut en aucun cas utiliser de produits détergents ou de solvants.

La société se réserve le droit de modifier, sans préavis, les caractéristiques de ses produits.

TECHNICAL ADVICE

The technical characteristics provided in this document are for information purposes only and are subject to change, due to permanent evolution of LED technology.

All dimensions are approximate and may vary slightly.

LIGHT BULBS

Use only the type of light bulb and maximum wattage shown otherwise you may damage the light fitting. Failure to use the correct light bulb and wattage will affect the warranty.

CARE INSTRUCTIONS

Wipe with a soft cloth –do not use any cleaning products. All our light fittings are lacquered to ensure the longevity of the product– under no circumstances use detergents or solvents.

The company reserves the right to modify its products at any time without notice.